

SERVICE SCHEDULE

Maintenance Intervals

Maintenance work must be done at regular intervals. Failure to do so will result in excessive wear and early failures.

The maintenance items listed under the maintenance intervals on the following pages are the required tasks to be performed. Those items provide additional details and include maintenance that is not shown on the decal.

All maintenance intervals are for machines operating in general environmental conditions. Keep in mind that filter and oil life can be reduced:

- When machines are operating in high dust environments or extreme temperature applications,
- When fuel is taken from uncontrolled storage tanks,
- When other non-standard conditions exist.

For more details, contact your Bobcat dealer.

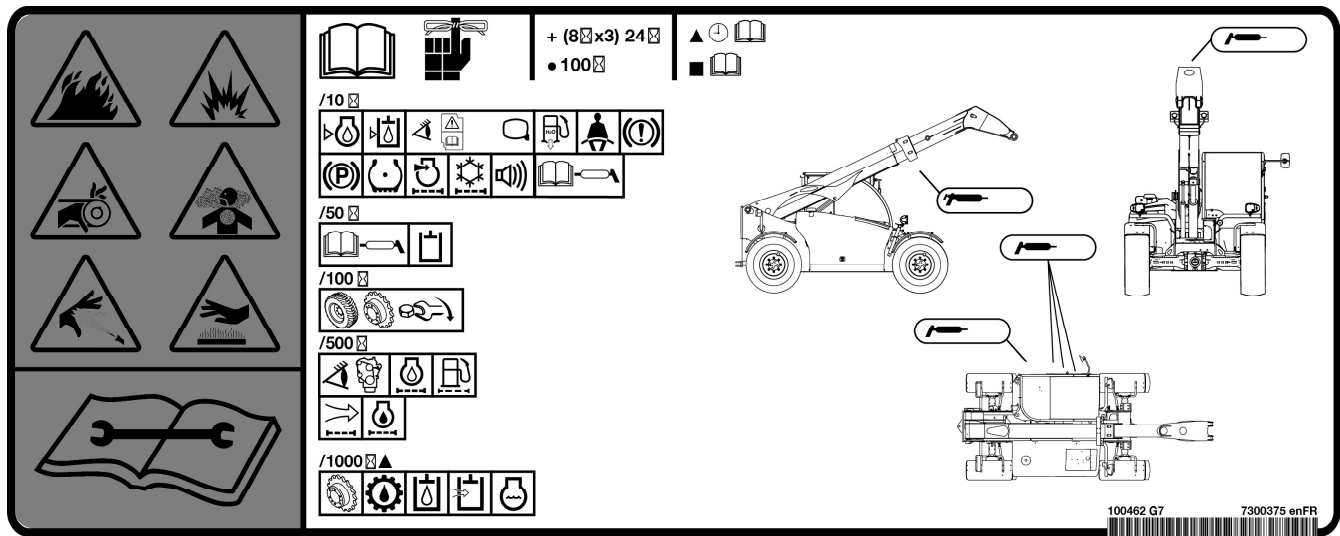

⚠ WARNING

INSUFFICIENT INSTRUCTIONS HAZARD

Untrained operators or failure to follow instructions can cause serious injury or death.







- Read and understand the Operation & Maintenance Manual, Operator's Handbook and decals on machine.
- Follow warnings and instructions in the manuals when making repairs, adjustments or servicing.
- Check for correct function after adjustments, repairs or service. ◀



Service Schedule











Explanation of the service intervals:







- **10:** Every 10 hours or daily (before starting the machine).
- **50:** Every 50 hours.
- **100:** Every 100 hours.
- **250:** Every 250 hours.
- **500:** Every 500 hours or every 12 months, whichever comes first.
- **1000:** Every 1000 hours or every 12 months, whichever comes first.
- **2000:** Every 2000 hours or every 24 months, whichever comes first.

- **3000:** Every 3000 hours or every 36 months, whichever comes first.

Service Schedule									
O	Check condition / proper operation. Adjust or replace as needed.	V	Refill as needed						
D	Check the display. Service only when required.	C	Clean						
W	Drain water	R	Replace						
F	First time only.	G	Grease						
Item	Service Required	Service Interval (hours)							
		10	50	100	250	500	1000	2000	3000
Tyres 	Condition and pressure. Use only approved tyres. (See Tyre Maintenance on Page 174)	O							
Engine Oil 	(See Engine Lubrication System on Page 149) • Engine Oil 10W30 (6987818) • Engine Oil 15W40 (6987819)	V					R		
Engine Oil Filter 	(See Engine Lubrication System on Page 149) • Engine Oil Filter (7343102)						R		
Exhaust system	Check exhaust system and exhaust aftertreatment components for leaks.	CO							
Cooling System 	Oil, charge air coolers and air conditioning condenser (if equipped). Keep cooling system free from debris. (See Cooling System on Page 151) Clean debris from radiator, air cooler, hydraulic fluid cooler, air conditioning condenser (if equipped), and grid.	VC-O						R	
	Coolant (See Cooling System on Page 151) • Engine Coolant (6987803)							R	
	Check coolant concentration (with a refractometer). Replace as needed.						V		
	Coolant level (check cold). (See Cooling System on Page 151) • Engine Coolant (6987803)	V							
Heater Coil and Air Conditioning Evaporator 	Contact your Bobcat dealer.							C	

Service Schedule										
O	Check condition / proper operation. Adjust or replace as needed.	V	Refill as needed							
D	Check the display. Service only when required.	C	Clean							
W	Drain water	R	Replace							
F	First time only.	G	Grease							
Item	Service Required	Service Interval (hours)								
		10	50	100	250	500	1000	2000	3000	
Grease Fittings 	Tilt cylinder rod end. (See Lubricating the Machine on Page 176)	G								
	Articulation pins, axle oscillation (front / rear), boom pivot, boom cylinder, self levelling (compensation) cylinder, frame-levelling cylinder, chain pulley pivots (front / rear). (See Lubricating the Machine on Page 176)		G							
Telescopic Boom Wear Pads 	(See Lubricating the Machine on Page 176)		G				O			
Attachment Carrier Pins	(See Lubricating the Machine on Page 176)	G								
LLMC System	Test the LLMC calibration. (See LLMC Calibration Test on Page 137)				FO	O				
Engine Air System and Air Filters 	Service when [AIR FILTER PLUGGED] is shown on display screen. Check for leaks and damaged components. (See Air Cleaner Service on Page 142) Empty dust extractor. (See Cleaning The Dust Extractor on Page 143) <ul style="list-style-type: none"> Outer Air Filter (7286652) Inner Air Filter (7010031) 	DO					O			
	Replace the outer filter element. (See Replacing The Outer Filter on Page 142) <ul style="list-style-type: none"> Outer Air Filter (7286652) 							R		
	Replace the inner filter element. (See Replacing The Inner Filter on Page 143) <ul style="list-style-type: none"> Inner Air Filter (7010031) 								R	

Service Schedule									
O	Check condition / proper operation. Adjust or replace as needed.	V	Refill as needed						
D	Check the display. Service only when required.	C	Clean						
W	Drain water	R	Replace						
F	First time only.	G	Grease						
Item	Service Required	Service Interval (hours)							
		10	50	100	250	500	1000	2000	3000
Fuel Filter 	(See Fuel Filter on Page 147) • Main Fuel Filter (7336334)	DW					DR		
	 (See Fuel System on Page 145) • Fuel Pre-Filter (7348032) • Fuel Tank Breather (7373582)							R	
Back-up Alarm and Horn 	Check for proper function. (See Multi-function Lever on Page 43) and (See Back-up Alarm System on Page 67)	O							
Seat Belt 	Check condition. Clean or replace seat belt retractors as needed. Clean dirt and debris from moving parts. (See Seat Belt on Page 136)	OC							
Hydraulic / Hydrostatic Fluid and Filter 	• Hydraulic Filter (7012477)			FR		R			
	 (See Hydraulic / Hydrostatic System on Page 162) • Hydraulic Fluid (6987791B)	V					R		
	 (See Removing And Installing The Fill / Breather Cap on Page 166) • Hydraulic Fill / Breather Cap (6727475)						R		
Hydraulic Hoses and Tubelines 	Contact your Bobcat dealer to replace any damaged hoses or tubelines.		O						
Parking Brake / Service Brake  	Check For Proper Function. (See Parking Brake on Page 66) and (See Service Brake Pedal And Inching Control on Page 52)	O							

Service Schedule										
O	Check condition / proper operation. Adjust or replace as needed.		V	Refill as needed						
D	Check the display. Service only when required.		C	Clean						
W	Drain water		R	Replace						
F	First time only.		G	Grease						
Item	Service Required	Service Interval (hours)								
		10	50	100	250	500	1000	2000	3000	
Safety Signs, Treads And Mirrors 	Check for damaged signs (decals), safety treads and mirrors. Replace any signs, safety treads or mirrors that are damaged or worn.	O								
Articulated Steering Links	Rubber protection. Contact your Bobcat dealer if damaged.		O							
Wheel Nut Torque 	(See Wheel Nuts on Page 174)	FO		O						
Alternator 	Belt. (See Alternator Belt on Page 171) .				O					R
Air-Conditioning (if equipped)	Belt. (See Air Conditioning Belt on Page 172)					O				R
Axle Central Housing and Differential 	(See Axles (Front and Rear) on Page 167) • Axle Oil (6987805)			FR	V		R [A]			
Planetary Carriers / Reduction Box	(See Axles (Front and Rear) on Page 167) • Axle Oil (6987794)									
Cab Air Filter 	(See Heating, Ventilation and Air Conditioning System (HVAC) on Page 141) • Cab Air Filter(7228497)						OC			
Battery 	Cables and electrical connections. (See Battery Maintenance on Page 159) • Battery (7288629)						O			