

Specifications & Options

Bobcat T40.180SLP T3

Performance

Rated capacity	4000 kg
Lifting height - tyres 24" Rim OD	16200 mm
Lifting height - stab 24" Rim OD	17466 mm
Max. reach - tyres 24" Rim OD	12800 mm

Load Charts

With forks and standard 400/80x24 tyres, on stabilisers

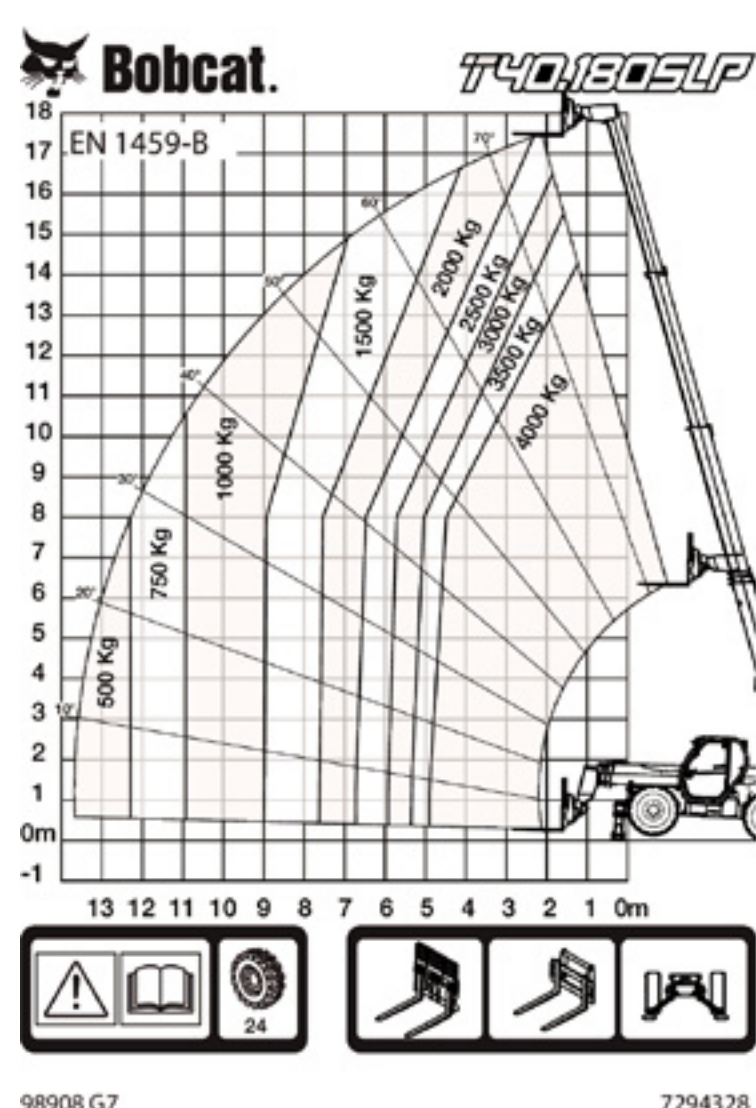

With forks and standard 400/80x24 tyres

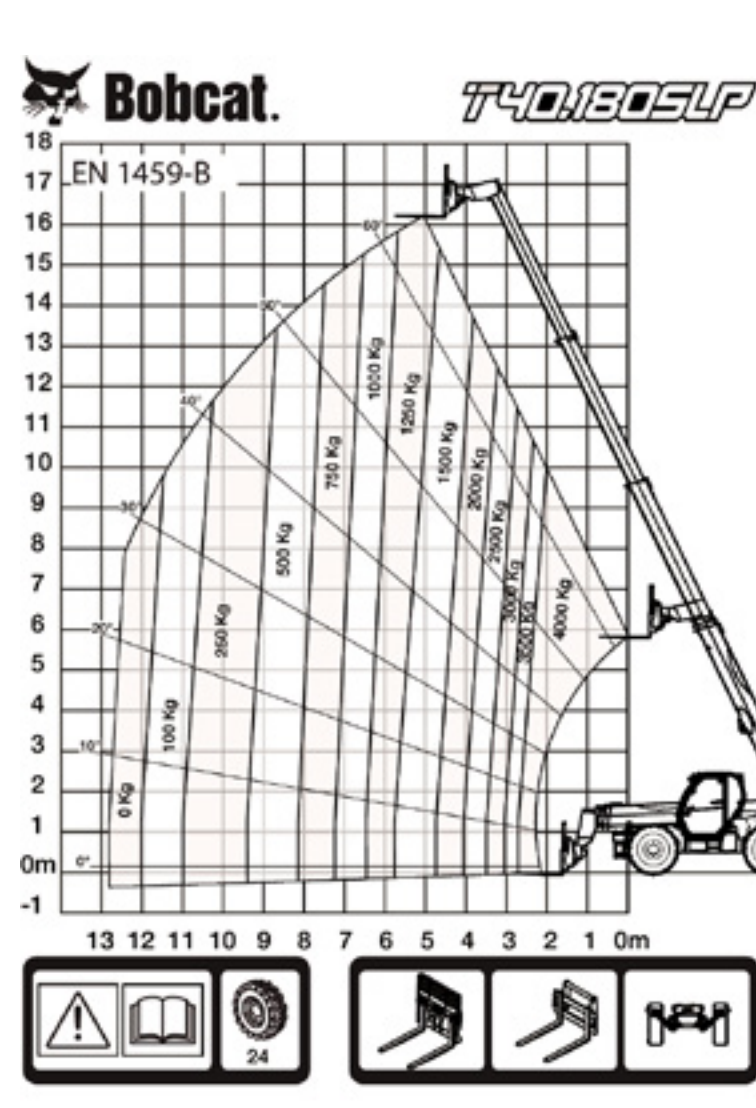

With jib on 20 or 24 inch tyres, on stabilisers

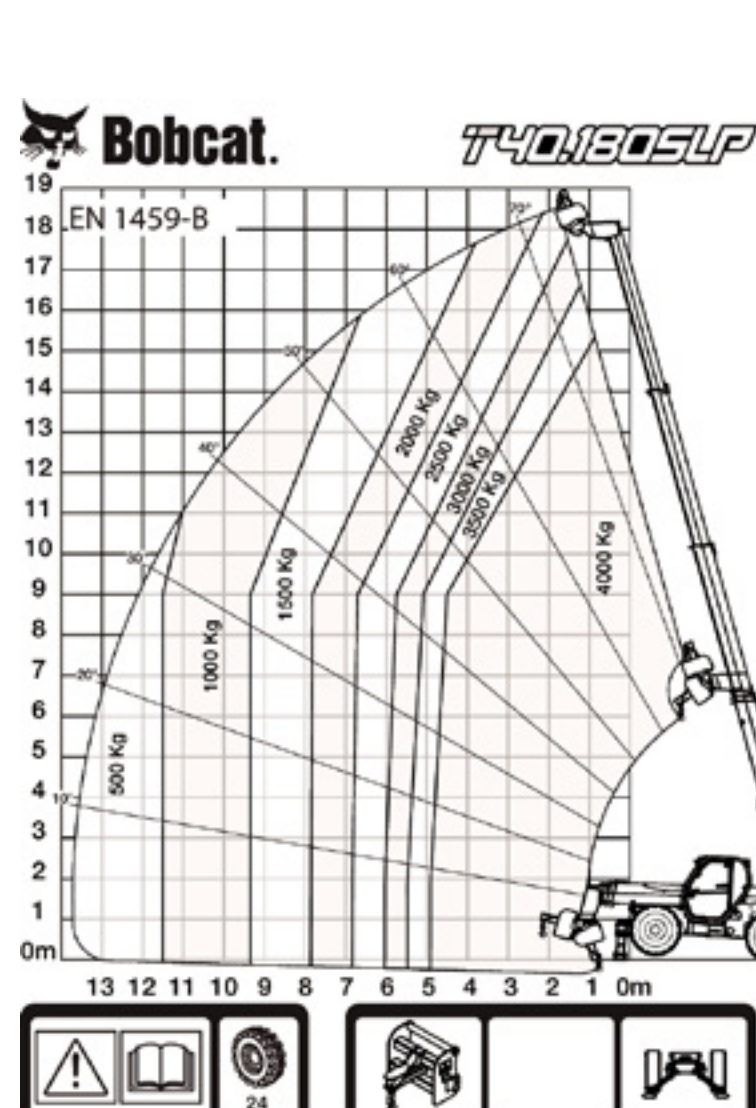

Weights

Total Operating Weight 20" Rim OD	N/A
-----------------------------------	-----

Engine

Make / Model	PERKINS / 1104D-44TA
Fuel	DIESEL
Cooling	WATER
Rated power (ISO 14396)	74.5 kW - 100HP @ 2200rpm
Maximum torque	410 Nm @ 1400rpm
Number of cylinders	4
Displacement	4.4 L

Hydraulic System

Work Pump type	Gear pump with LS valve
Work Pump capacity	100 l/min
Relief valve pressure setting	255 bar

Drive System

Transmission	Hydrostatic with electronic regulation
Main Drive	Hydrostatic motor

Brakes

Engine Braking	Hydrostatic
Automatic Parking and Emergency brake	Passive brake

Dimensions

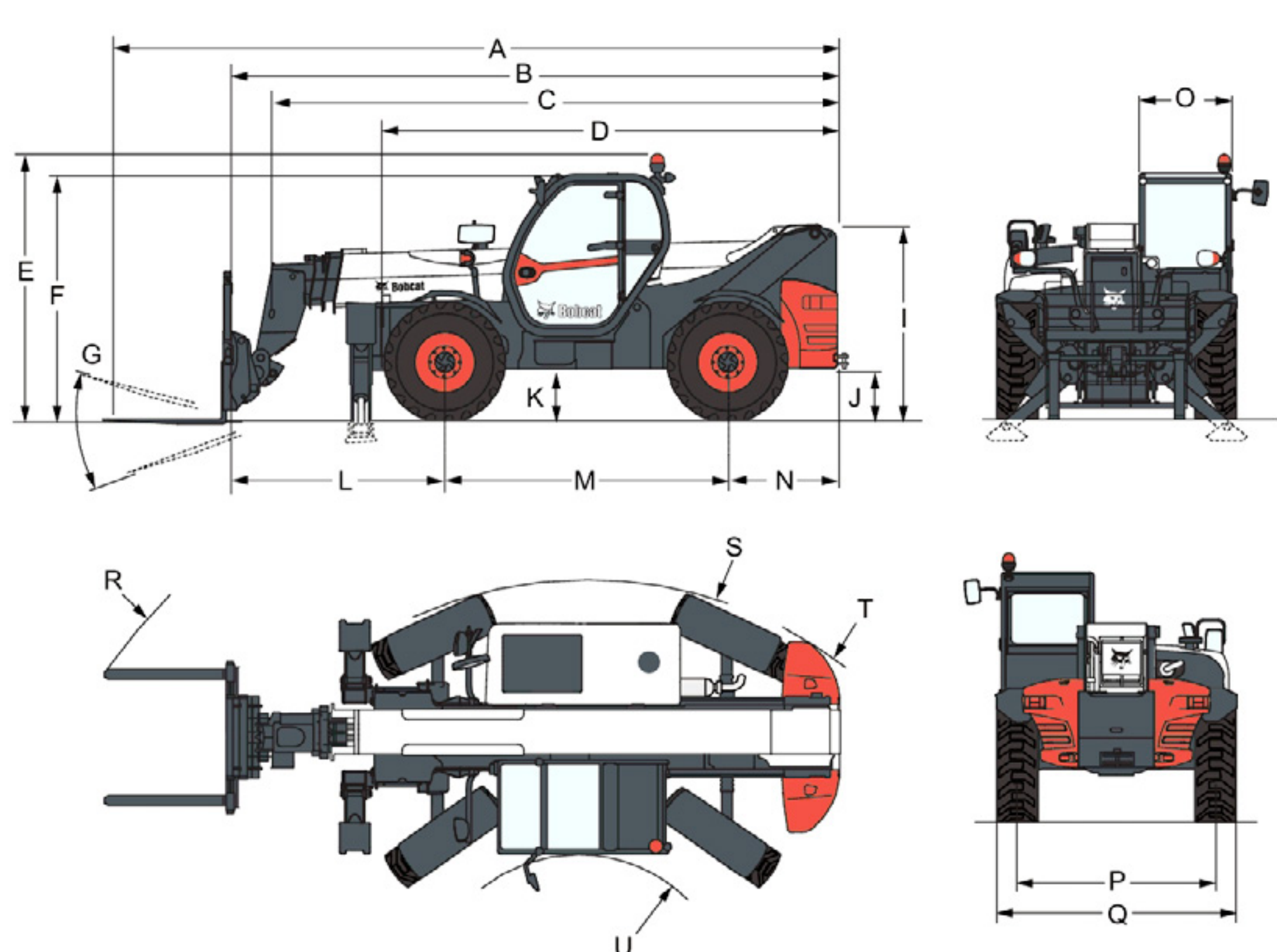

Overall length (to forks tip)	7425 mm
Overall length (to forks face)	6220 mm
Overall length (to carrier pin)	5821 mm
Overall length (to front tyres)	N/A
Overall length (to front tyres)	4573 mm
Overall height std cab (with rotating beacon)	N/A
Overall height std cab (with rotating beacon)	2673 mm
Overall height high cab (with rotating beacon)	N/A
Overall height high cab (with rotating beacon)	N/A
Overall height std cab	N/A
Overall height std cab	2480 mm
Overall height high cab	N/A
Overall height high cab	N/A
Height back of the machine	N/A
Height back of the machine	1956 mm
Ground clearance	N/A
Ground clearance	509 mm
Length - Front axle to forks face	2263 mm
Wheelbase	2850 mm
Length - Rear axle to machine rear	1107 mm
Operator cab outside width	930 mm
Operator cab inside width	857 mm
Track width (front & rear)	1992 mm
Width over standard tyres	2418 mm
External turning radius (at tyres)	N/A
External turning radius (at tyres)	4150 mm
Internal turning radius (cab)	N/A
Internal turning radius (cab)	1519 mm
Internal turning radius (engine basket)	N/A
Internal turning radius (engine basket)	1614 mm
External turning radius (with forks spaced 1040 mm ext.)	N/A
External turning radius (with forks spaced 1040 mm ext.)	-
External turning radius (with forks spaced 1360 mm ext.)	-
External turning radius (with forks spaced 1360 mm ext.)	-
External turning radius (dig bucket)	N/A
External turning radius (dig bucket)	5985 mm
Carriage rotation angle	124 deg